



为您的产品保驾护航

PRODUCT DATASHEET

Electro-Static Discharge

JEN1006-3.3V-ULC ESD

Features

- Ultra small package: 1.0x0.6x0.5mm(DFN1006)
- Ultra low capacitance: 0.6pF typical
- Ultra low leakage: nA level
- Operating voltage: 3.3V
- Low clamping voltage
- Complies with following standards:
 - IEC 61000-4-2 (ESD) immunity test
Air discharge: ±30kV
Contact discharge: ±30kV
 - IEC61000-4-5 (Lightning) 10A (8/20µs)
- RoHS Compliant

Pin Description



Applications

- Cellular Handsets and Accessories
- Display Ports
- MDDI Ports
- USB Ports
- Digital Visual Interface (DVI)
- PCI Express and Serial SATA Ports

Schematic Diagram

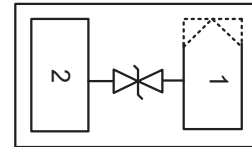

Limiting Values(T_A = 25 °C, unless otherwise specified)

Symbol	Parameter	Conditions	Min	Max	Unit
V _{ESD}	Electrostatic Discharge Voltage	IEC 61000-4-2;Contact Discharge	-	±30	kV
		IEC 61000-4-2;Air Discharge	-	±30	kV
P _{PP}	Peak Pulse Power	t _p =8/20µs	-	50	W
I _{PP}	Rated Peak Pulse Current	t _p =8/20µs	-	10	A
T _J	Operating Temperature Range	-	-55	125	°C
T _{stg}	Storage Temperature Range	-	-55	150	°C

Electrical Characteristics(T_A = 25 °C, unless otherwise specified)

Symbol	Parameter	Conditions	Min	Typ.	Max	Unit
V _{RWM}	Reverse Working Voltage	T _A =25°C	-	-	3.3	V
V _{PT}	Punch-Through Voltage	I _T =2µA;T _A =25°C	3.5	-	-	V
V _{SB}	Snap-Back Voltage	I _T =50mA;T _A =25°C	0.8	-	-	V
I _R	Reverse Leakage Current	V _{RWM} =3.3V	-	-	0.2	µA
V _C	Clamping Voltage	I _{PP} =1A(8x20µs pulse)	-	4	-	V
V _C	Clamping Voltage	I _{PP} =10A(8x20µs pulse)	-	5	-	V
C _J	Junction Capacitance	V _R =0V,f=1 MHz	-	0.6	-	pF

Typical Characteristics

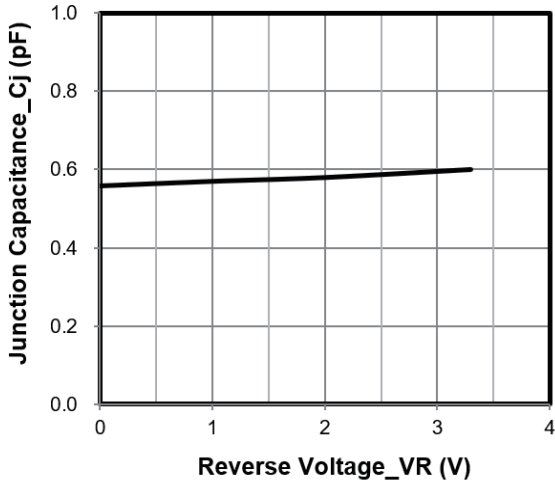

Junction Capacitance vs. Reverse Voltage

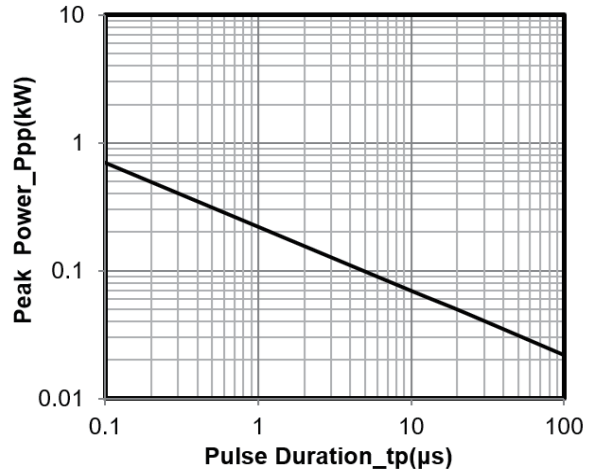

Peak Pulse Power vs. Pulse Time

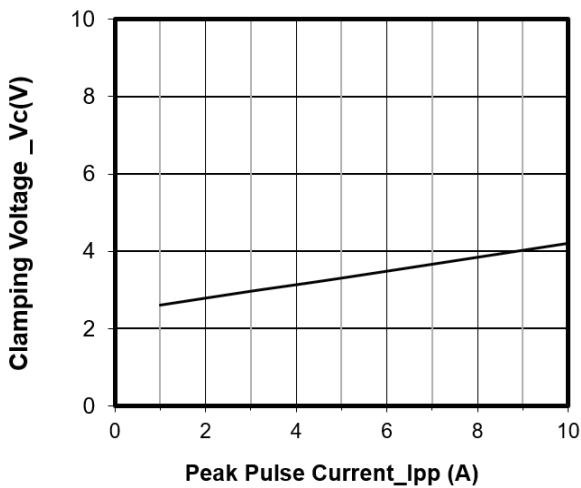

Clamping Voltage vs. Peak Pulse Current

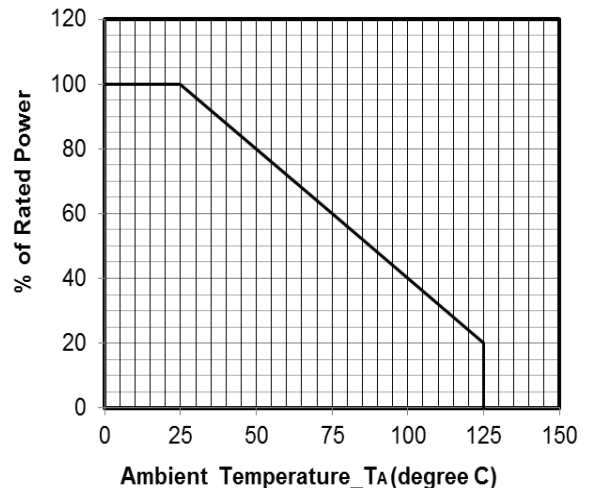

Power Derating Curve

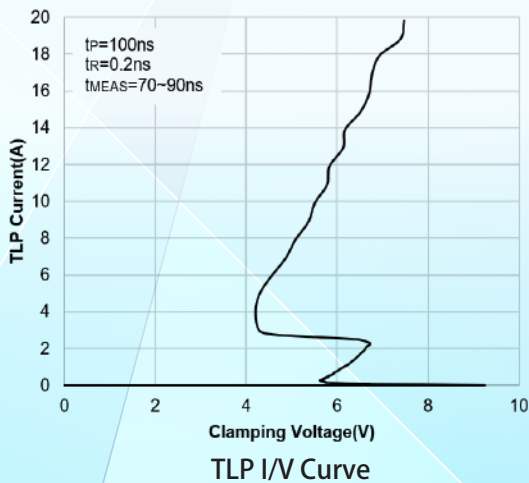

TLP I/V Curve

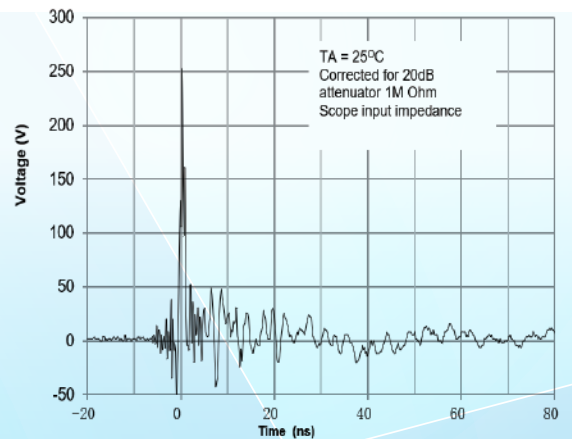

ESD Clamping Voltage
8 kV Contact per IEC61000-4-2

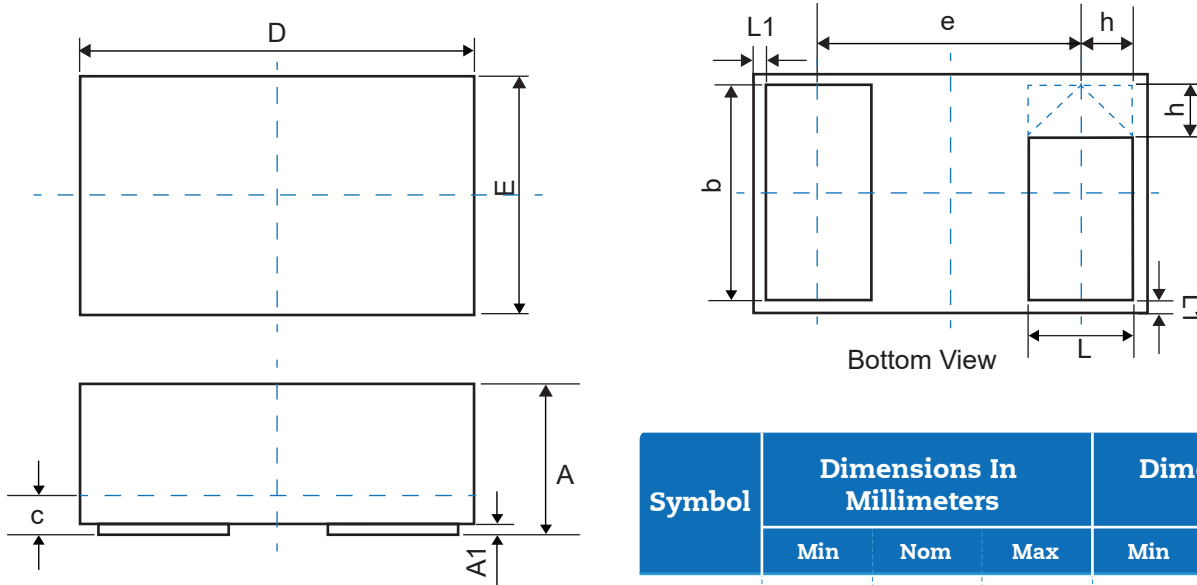
Physical Dimensions(mm.)

Symbol	Dimensions In Millimeters			Dimensions In Inches		
	Min	Nom	Max	Min	Nom	Max
A	0.45	0.50	0.55	0.018	0.020	0.022
A1	0.00	0.02	0.05	0.000	0.001	0.002
b	0.45	0.50	0.55	0.018	0.020	0.022
c	0.12	0.15	0.18	0.005	0.006	0.007
D	0.95	1.00	1.05	0.037	0.039	0.041
e	0.65 BSC			0.026 BSC		
E	0.55	0.60	0.65	0.022	0.024	0.026
L	0.20	0.25	0.30	0.008	0.010	0.012
L1	0.05 REF			0.002 REF		
h	0.07	0.12	0.17	0.003	0.005	0.007

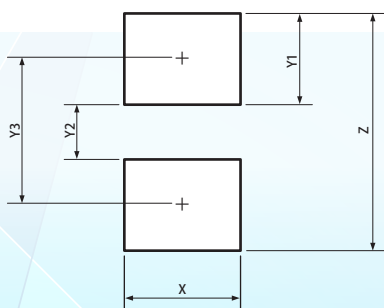
Suggested Land Pattern

Symbol	Dimensions	
	Millimeters	Inches
X	0.60	0.024
Y1	0.50	0.020
Y2	0.30	0.012
Y3	0.80	0.032
Z	1.30	0.052

Packaging Quantity

Part Number	Size(mm)	Delivery Form	Delivery Quantity
JEN1006-3.3V-ULC	1.0x0.6x0.5	7" T&R	10,000

Soldering Parameters

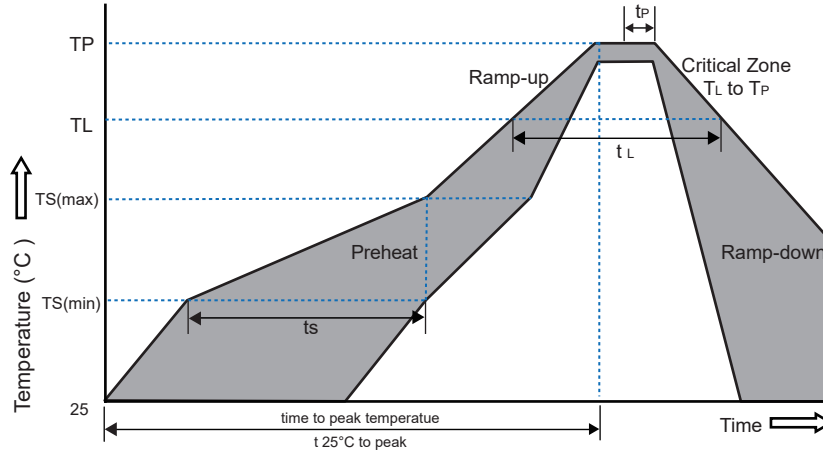

Reflow Condition		Pb-Free Assembly
Pre-heat	-Temperature Min($T_{s(min)}$)	+150°C
	-Temperature Max($T_{s(max)}$)	+200°C
	-Time(Min to Max)(t_s)	60~180 secs.
Average ramp up rate (Liquid us Temp(T_L) to peak)		3°C/sec. Max
Ts(max) to T_L - Ramp-up Rate		3°C/sec. Max
Reflow	-Temperature(T_L)(Liquid us)	+217°C
	-Temperature (t_L)	60~150 secs.
Peak Temp (T_p)		+260(+0/-5)°C
Time within 5°C of actual Peak Temp (t_p)		30 secs. Max
Ramp-down Rate		6°C/sec. Max
xTime 25°C to Peak Temp (TP)		8 min. Max
Do not exceed		+260°C

Part Number System

JE N1006 - 3.3V - UL C

