



为您的产品保驾护航

PRODUCT DATASHEET

Electro-Static Discharge

JEN1006-4.5V-C ESD

Features

- Ultra small package: 1.0x0.6x0.5mm(DFN1006)
- Protects one data or power line
- Ultra low leakage: nA level
- Operating voltage: 4.5V
- Low clamping voltage
- 2-pin leadless package
- Complies with following standards:
 - IEC 61000-4-2 (ESD) immunity test
Air discharge: $\pm 30\text{kV}$
Contact discharge: $\pm 30\text{kV}$
 - IEC61000-4-5 (Lightning) 40A (8/20 μs)
- RoHS Compliant

Pin Description



Applications

- Cellular Handsets and Accessories
- Personal Digital Assistants
- Notebooks and Handhelds
- Portable Instrumentation
- Digital Cameras
- Peripherals
- Keypads, Side Keys, LCD Displays

Schematic Diagram

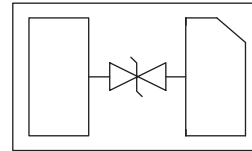

Limiting Values($T_A = 25^\circ\text{C}$, unless otherwise specified)

Symbol	Parameter	Conditions	Min	Max	Unit
V _{ESD}	Electrostatic Discharge Voltage	IEC 61000-4-2;Contact Discharge	-	± 30	kV
		IEC 61000-4-2;Air Discharge	-	± 30	kV
P _{PP}	Peak Pulse Power	t _p =8/20 μs	-	400	W
I _{PP}	Rated Peak Pulse Current	t _p =8/20 μs	-	40	A
T _J	Operating Temperature Range	-	-55	125	$^\circ\text{C}$
T _{stg}	Storage Temperature Range	-	-55	150	$^\circ\text{C}$

Electrical Characteristics($T_A = 25^\circ\text{C}$, unless otherwise specified)

Symbol	Parameter	Conditions	Min	Typ.	Max	Unit
V _{RWM}	Reverse Working Voltage	T _A =25 $^\circ\text{C}$	-	-	4.5	V
V _{BR}	Breakdown Voltage	I _T =1 mA;T _A =25 $^\circ\text{C}$	4.8	-	-	V
I _R	Reverse Leakage Current	V _{RWM} =4.5V	-	-	0.2	μA
V _C	Clamping Voltage	I _{PP} =1A,t _p =8/20 μs	-	-	6.5	V
V _C	Clamping Voltage	I _{PP} =40A,t _p =8/20 μs	-	-	10	V
C _J	Junction Capacitance	V _R =0V,f=1 MHz	-	100	-	pF

Typical Characteristics

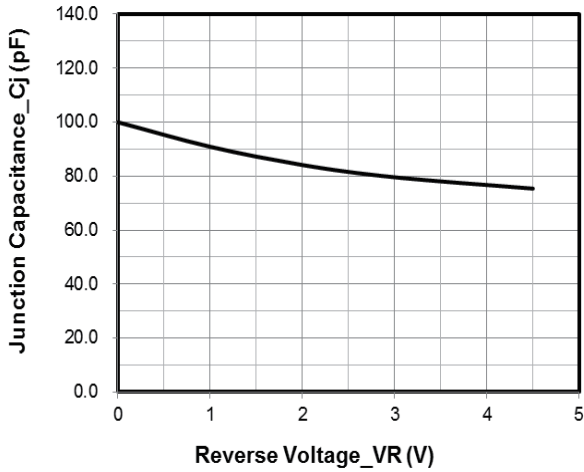

Junction Capacitance vs. Reverse Voltage

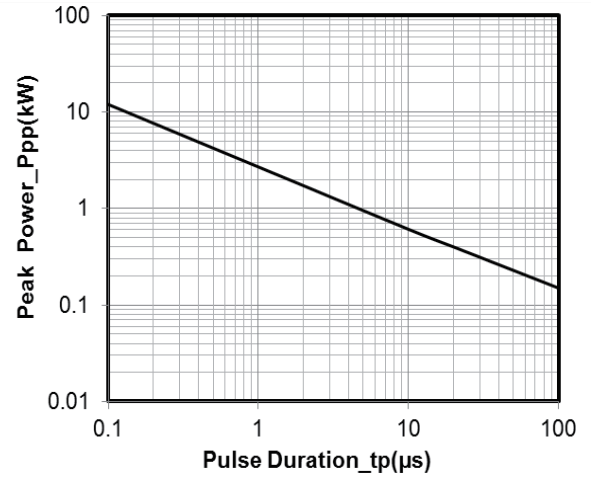

Peak Pulse Power vs. Pulse Time

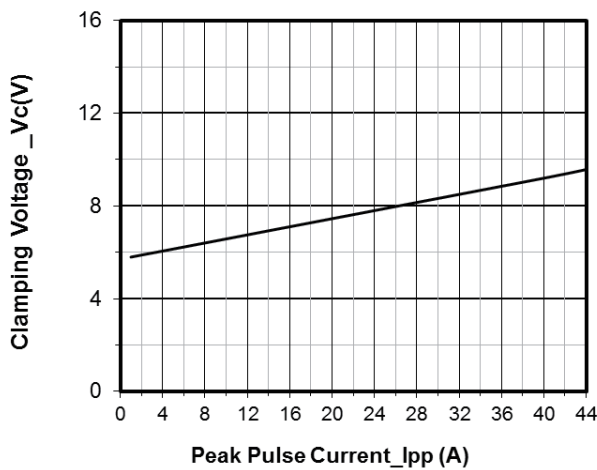

Clamping Voltage vs. Peak Pulse Current (tp = 8/20 μs)

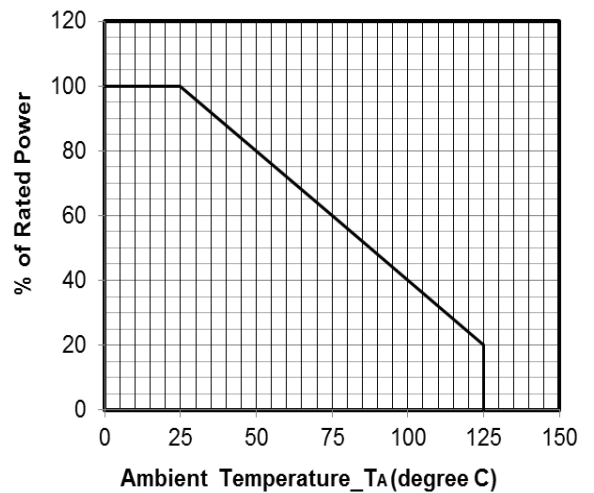

Power Derating Curve

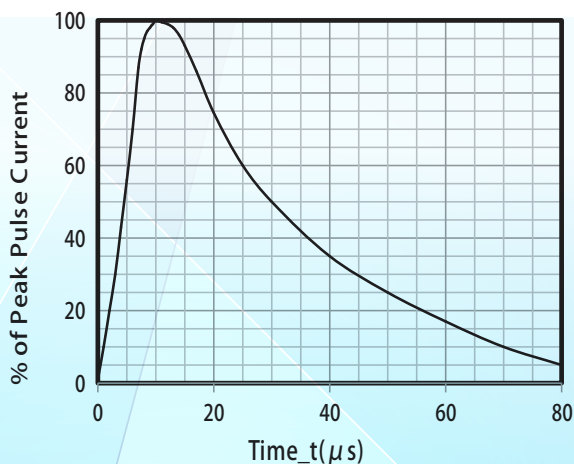

8 X 20 μs Pulse Waveform

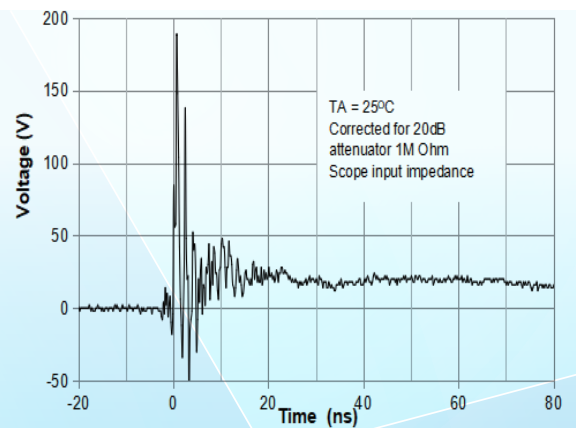

ESD Clamping Voltage
8 kV Contact per IEC61000-4-2

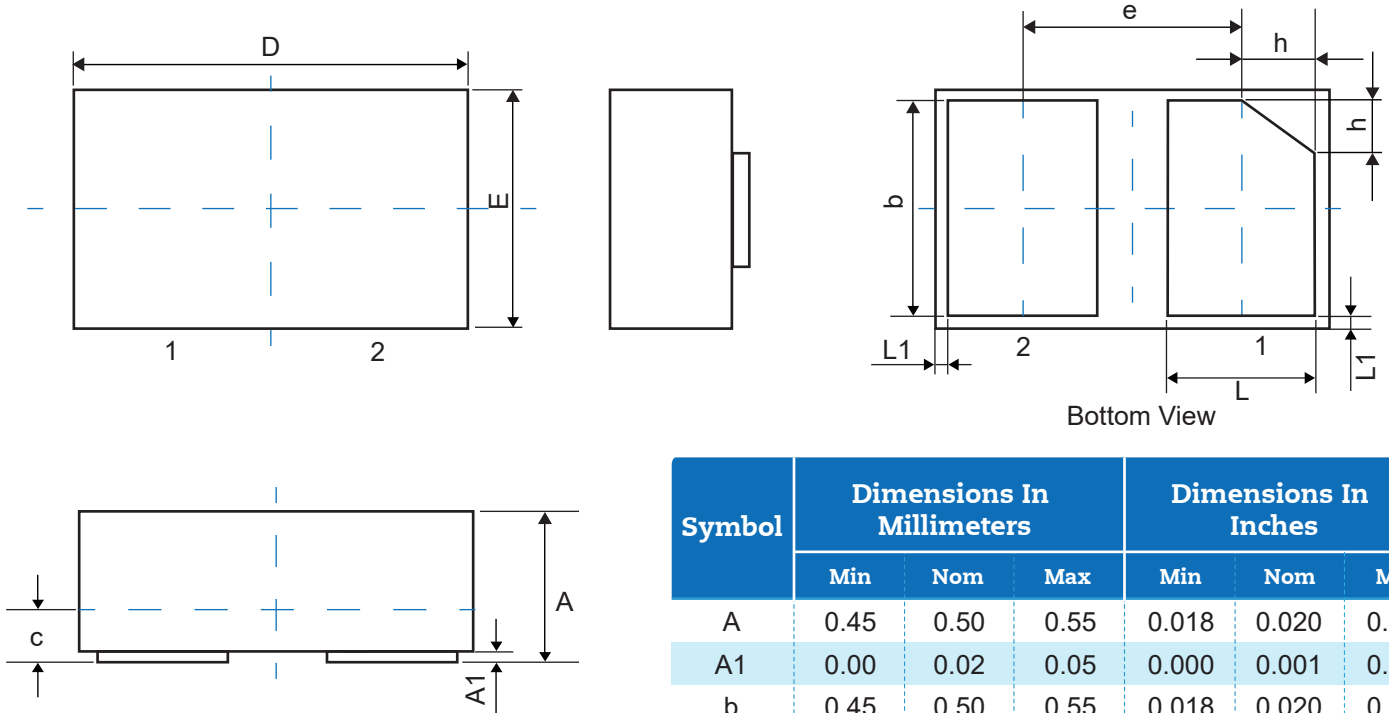
Physical Dimensions(mm.)

Symbol	Dimensions In Millimeters			Dimensions In Inches		
	Min	Nom	Max	Min	Nom	Max
A	0.45	0.50	0.55	0.018	0.020	0.022
A1	0.00	0.02	0.05	0.000	0.001	0.002
b	0.45	0.50	0.55	0.018	0.020	0.022
c	0.12	0.15	0.18	0.005	0.006	0.007
D	0.95	1.00	1.05	0.037	0.039	0.041
e	0.65 BSC			0.026 BSC		
E	0.55	0.60	0.65	0.022	0.024	0.026
L	0.20	0.25	0.30	0.008	0.010	0.012
L1	0.05 REF			0.002 REF		
h	0.07	0.12	0.17	0.003	0.005	0.007

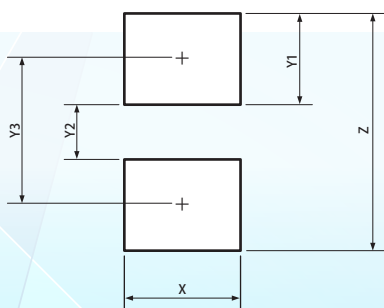
Suggested Land Pattern

Symbol	Dimensions	
	Millimeters	Inches
X	0.60	0.024
Y1	0.50	0.020
Y2	0.30	0.012
Y3	0.80	0.032
Z	1.30	0.052

Packaging Quantity

Part Number	Size(mm)	Delivery Form	Delivery Quantity
JEN1006-4.5V-C	1.0x0.6x0.5	7" T&R	10,000

Soldering Parameters

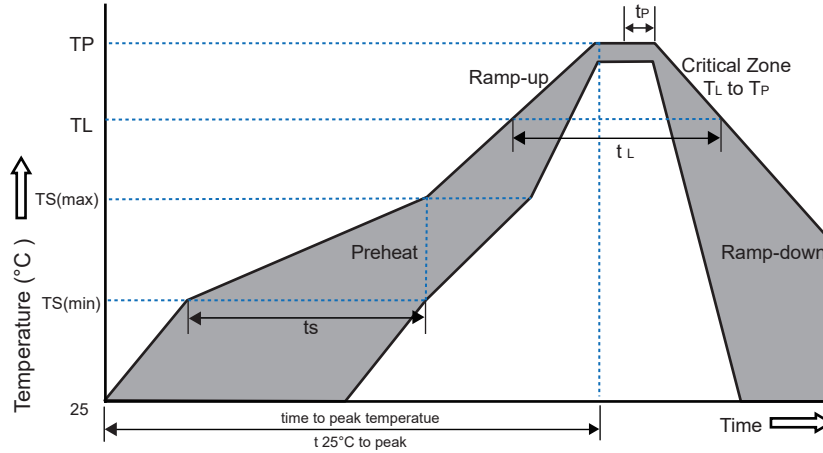

Reflow Condition		Pb-Free Assembly
Pre-heat	-Temperature Min($T_{s(min)}$)	+150°C
	-Temperature Max($T_{s(max)}$)	+200°C
	-Time(Min to Max)(t_s)	60~180 secs.
Average ramp up rate (Liquid us Temp(T_L) to peak)		3°C/sec. Max
Ts(max) to T_L - Ramp-up Rate		3°C/sec. Max
Reflow	-Temperature(T_L)(Liquid us)	+217°C
	-Temperature (t_L)	60~150 secs.
Peak Temp (T_p)		+260(+0/-5)°C
Time within 5°C of actual Peak Temp (t_p)		30 secs. Max
Ramp-down Rate		6°C/sec. Max
xTime 25°C to Peak Temp (TP)		8 min. Max
Do not exceed		+260°C

Part Number System

JE N1006 - 4.5V - C

C=Bi-directional
 Blank=Uni-directional

Working Voltage: 4.5V

DFN1006

JDT ESD